



# COMBiLiFT

Customised Handling Solutions

## COMBi<sup>®</sup>-WR

Walkie Reach



### Load Capacity Chart

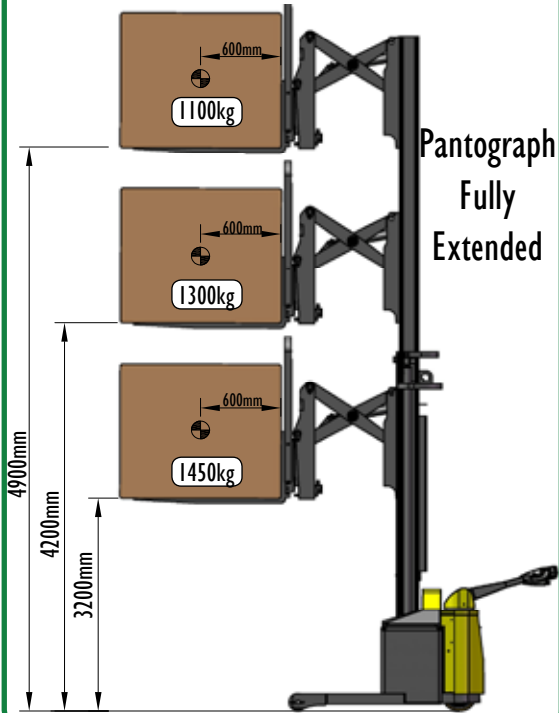

### Multi Position Tiller- International Application No. PCT/EP2012/067238

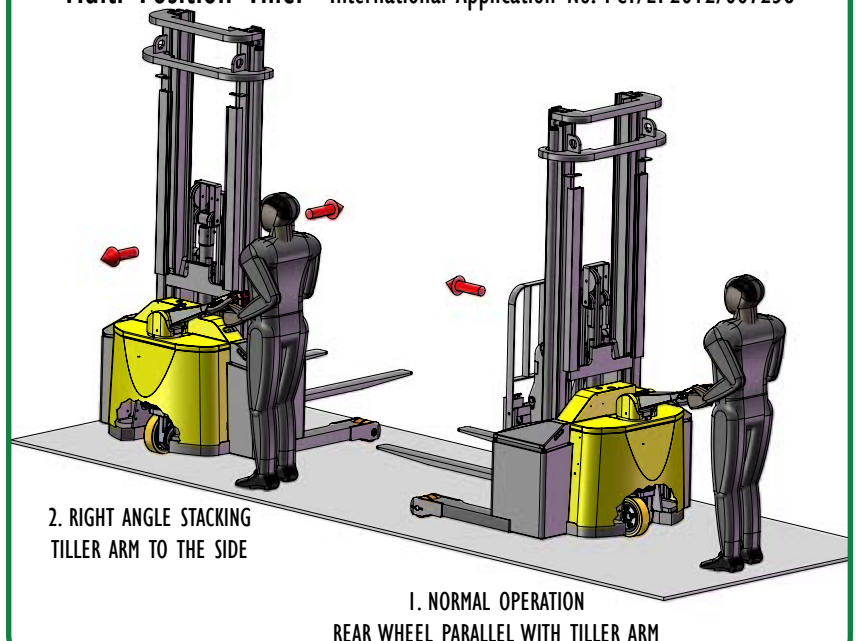



# SPECIFICATIONS

# COMBi<sup>®</sup>-WR

International Application No. PCT/EP2012/067238  
Multi Position Tiller.

	DESCRIPTION	STD	OPTIONAL	
1a	Max. Lift Height	3000mm	4200mm	4900mm
1b	Free Lift Height	900mm	1500mm	1850mm
2	Height Mast Closed	2100mm	2700mm	3050mm
3	Max. (Mast Raised)	4200mm	5400mm	6100mm
4	Overall Length		1950mm	
5	Fork Travel		590mm	
6	Ground Clearance Under Mast		80mm	
7	Ground Clearance to Centre of Wheelbase		50mm	
8	Width		1320mm	
9	Outside Spread of Fork Arms		815mm	
10	Track Front		1165mm	
11	Frame Opening		1008mm	
12	Load Centre Distance		600mm	
13	Overhang Front		603mm	
14	Wheelbase		1172mm	
15	Overhang Back		175mm	
16	Fork Side Shift		80mm Left / 80mm Right	
17	Length from Face of Fork		880mm	
18	Fork Backward Tilt		3°	
19	Fork Forward Tilt		3°	
20	Minimum Outside Radius		1350mm	
21	Leg Height		127mm	
22	Leg Length		530mm	
A	Capacity		1450kg @ 3200mm Lift	
B	Unladen Weight		2500kg /2600kg/ 2700kg	
C	Maximum Ground Speed		6 Km/h	
D	Gradability		5%	
E	Battery Capacity		24V / 270 Ah	
F	Fork Section		35mm x 100mm x 1070mm	
G	Front Tyre (Polyurethane)		OD 127mm / Width 75mm	
H	Rear Tyre (Vulkollan)		OD 250mm / Width 75mm	
I	Standard Colour		Yellow & Grey	
J	AC Electric Traction Motor		24V / 2.5 kW	
K	AC Electric Pump Motor		24V / 5 kW	

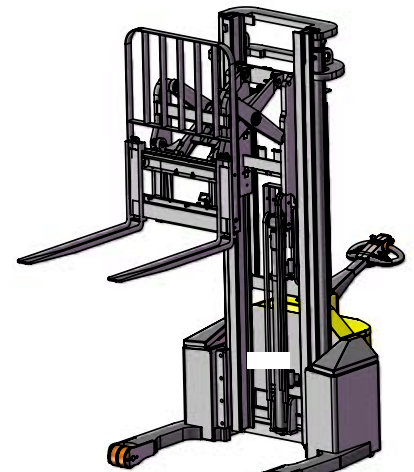
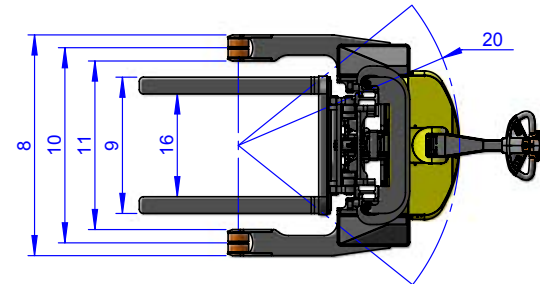
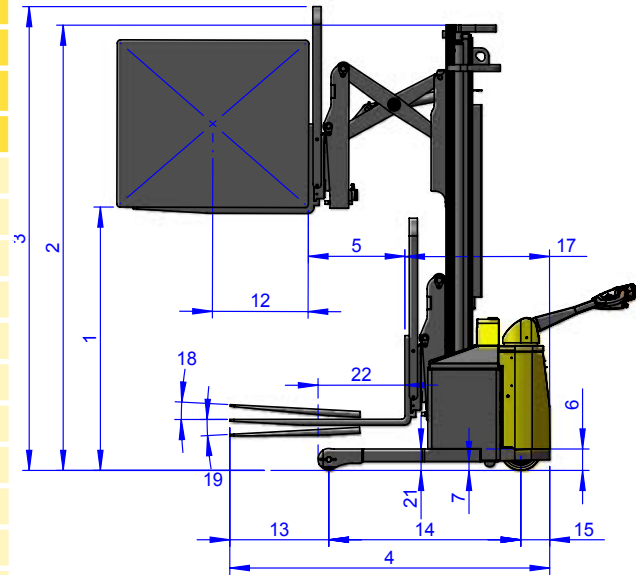

### Features Include:

- Pantograph
- Power Steering
- AC Motor Technology
- 1000mm High Load Back Rest
- Rear Wheel Drive
- 80/80mm Side Shift

Distributed by:

**COMBiLIFT**

Co. Monaghan  
Ireland

T: +353 47 80500

F: +353 47 80501

E: info@combilift.com

[www.COMBiLIFT.com](http://www.COMBiLIFT.com)